

Keysight Technologies

Evaluating Oscilloscope Sample Rates vs. Sampling Fidelity

Application Note

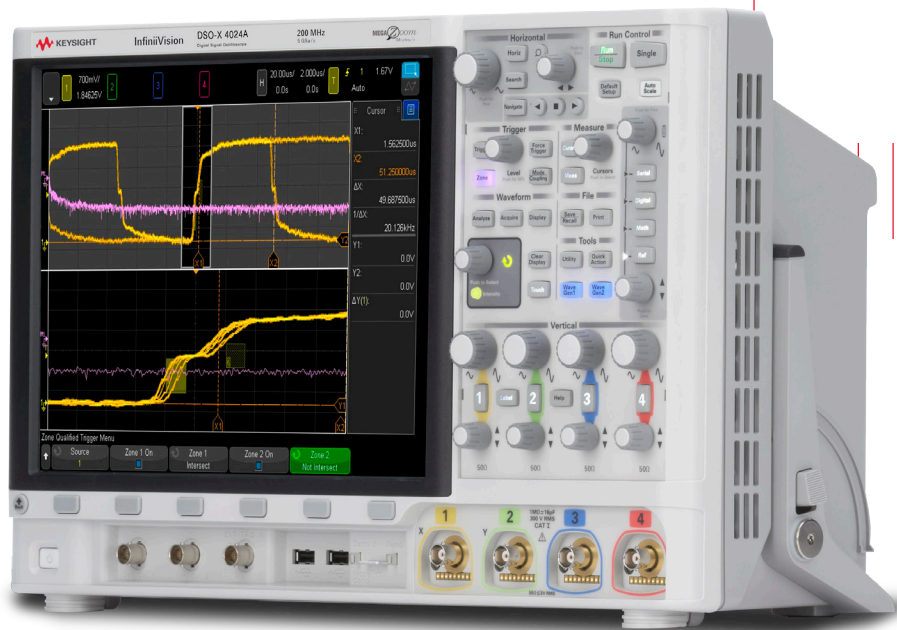



Introduction

How to Make the Most Accurate Digital Measurements

Digital storage oscilloscopes (DSO) are the primary tools used today by digital designers to perform signal integrity measurements such as setup/hold times, eye margin, and rise/fall times. The two key banner specifications that affect an oscilloscope's signal integrity measurement accuracy are bandwidth and sample rate. Most engineers have a good idea of how much bandwidth they need for their digital measurements. However, there is often a lot of confusion about required sample rates—and engineers often assume that scopes with the highest sample rates produce the most accurate digital measurements. But is this true?

When you select an oscilloscope for accurate, high-speed digital measurements, sampling fidelity can often be more important than maximum sample rate. Using side-by-side measurements on oscilloscopes with various bandwidths and sample rates, this application note demonstrates a counterintuitive concept: scopes with higher sample rates can exhibit poorer signal fidelity because of poorly aligned interleaved analog-to-digital converters (ADCs). This application note also will show how to easily characterize and compare scope ADC sampling fidelity using both time-domain and frequencydomain analysis techniques.

Let's begin with a discussion of minimum required sample rate and a review of Nyquist's sampling theorem.

Table of Contents

Introduction	2
Nyquist's Sampling Theorem	3
Interleaved Real-Time Sampling	7
Testing for Interleave Distortion	9
Effective number of bits analysis	9
Visual sine wave comparison tests	10
Spectrum analysis comparison tests ..	13
Summary	16
Related Keysight Literature	16
Glossary	17

Nyquist's Sampling Theorem

How much sample rate do you need for your digital measurement applications? Some engineers have total trust in Nyquist and claim that just 2X sampling over the scope's bandwidth is sufficient. Other engineers don't trust digital filtering techniques based on Nyquist criteria and prefer that their scopes sample at rates that are 10X to 20X over the scope's bandwidth specification. The truth actually lies somewhere in between. To understand why, you must have an understanding of the Nyquist theorem and how it relates to a scope's frequency response. Dr. Harry Nyquist (Figure 1) postulated:



Figure 1: Dr. Harry Nyquist, 1889-1976, articulated his sampling theorem in 1928

Nyquist Sampling Theorem

For a limited bandwidth signal with a maximum frequency f_{MAX} , the equally-spaced sampling frequency f_S must be greater than twice the maximum frequency f_{MAX} , in order to have the signal be uniquely reconstructed without aliasing.

Nyquist's sampling theorem can be summarized into two simple rules—but perhaps not-so-simple for DSO technology.

1. The highest frequency component sampled must be less than half the sampling frequency.
2. The second rule, which is often forgotten, is that samples must be equally spaced.

What Nyquist calls f_{MAX} is what we usually refer to as the Nyquist frequency (f_N), which is not the same as oscilloscope bandwidth (f_{BW}). If an oscilloscope's bandwidth is specified exactly at the Nyquist frequency (f_N), this implies that the oscilloscope has an ideal brick-wall response that falls off exactly at this same frequency, as shown in Figure 2. Frequency components below the Nyquist frequency are perfectly passed (gain =1), and frequency components above the Nyquist frequency are perfectly eliminated. Unfortunately, this type of frequency response filter is impossible to implement in hardware.

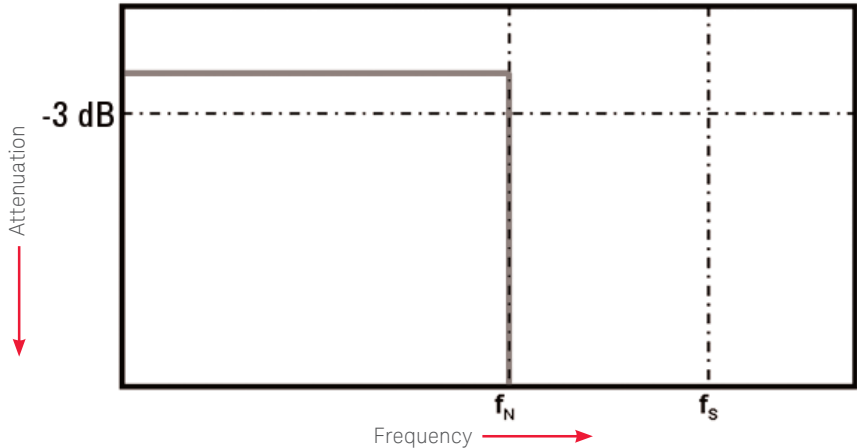

Figure 2: Theoretical brick-wall frequency response

Nyquist's Sampling Theorem (continued)

Most oscilloscopes with bandwidth specifications of 1 GHz and below have what is known as a Gaussian frequency response. As signal input frequencies approach the scope's specified bandwidth, measured amplitudes slowly decrease. Signals can be attenuated by as much as 3 dB (~30%) at the bandwidth frequency. If a scope's bandwidth is specified exactly at the Nyquist frequency (f_N), as shown in Figure 3, input signal frequency components above this frequency—although attenuated by more than 3 dB—can be sampled (red hashed area)—especially when the input signal contains fast edges, as is often the case when you are measuring digital signals. This is a violation of Nyquist's first rule.

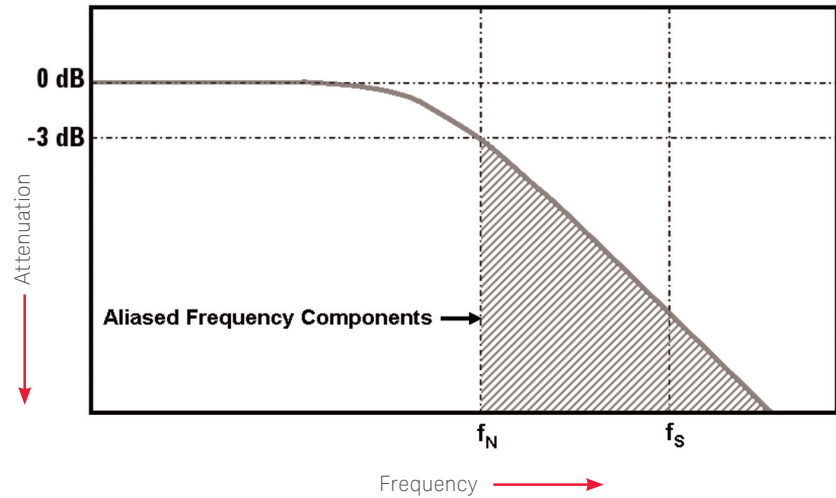

Figure 3: Typical oscilloscope Gaussian frequency response with bandwidth (f_{BW}) specified at the Nyquist frequency (f_N)

Most scope vendors don't specify their scope's bandwidth at the Nyquist frequency (f_N)—but some do. However, it is very common for vendors of waveform recorders/digitizers to specify the bandwidth of their instruments at the Nyquist frequency. Let's now see what can happen when a scope's bandwidth is the same as the Nyquist frequency (f_N).

Figure 4 shows an example of a 500-MHz bandwidth scope sampling at just 1 GSa/s while operating in a three- or four-channel mode. Although the fundamental frequency (clock rate) of the input signal is well within Nyquist's criteria, the signal's edges contain significant frequency components well beyond the Nyquist frequency (f_N). When you view them repetitively, the edges of this signal appear to “wobble” with varying degrees of pre-shoot, over-shoot, and various edge speeds. This is evidence of aliasing, and it clearly demonstrates that a sample rate-to-bandwidth ratio of just 2:1 is insufficient for reliable digital signal measurements.

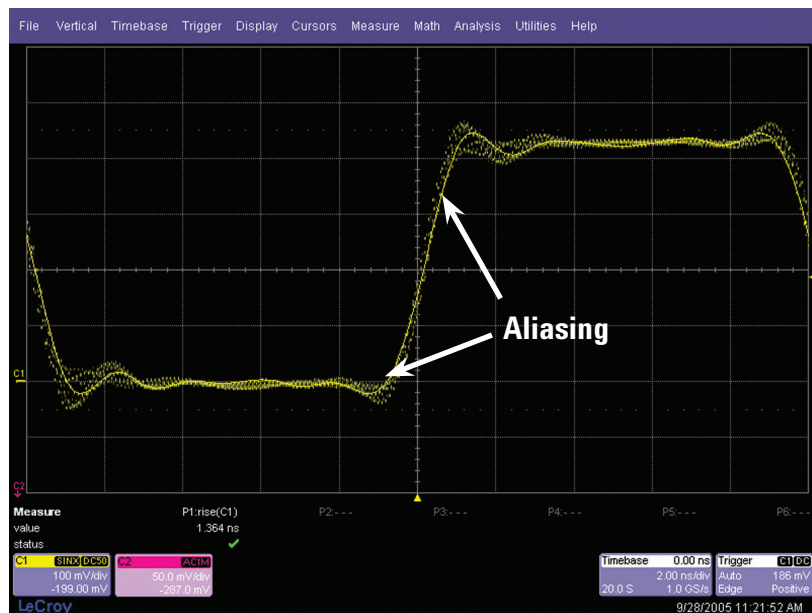

Figure 4: 500-MHz bandwidth scope sampling at 1 GSa/s produces aliased edges

Nyquist's Sampling Theorem (continued)

So, where should a scope's bandwidth (f_{BW}) be specified relative to the scope's sample rate (f_S) and the Nyquist frequency (f_N)? To minimize sampling significant frequency components above the Nyquist frequency (f_N), most scope vendors specify the bandwidth of their scopes that have a typical Gaussian frequency response at 1/4th to 1/5th, or lower, than the scope's real-time sample rate, as shown in Figure 5. Although sampling at even higher rates relative to the scope's bandwidth would further minimize the possibility of sampling frequency components beyond the Nyquist frequency (f_N), a sample rate-to-bandwidth ratio of 4:1 is sufficient to produce reliable digital measurements.

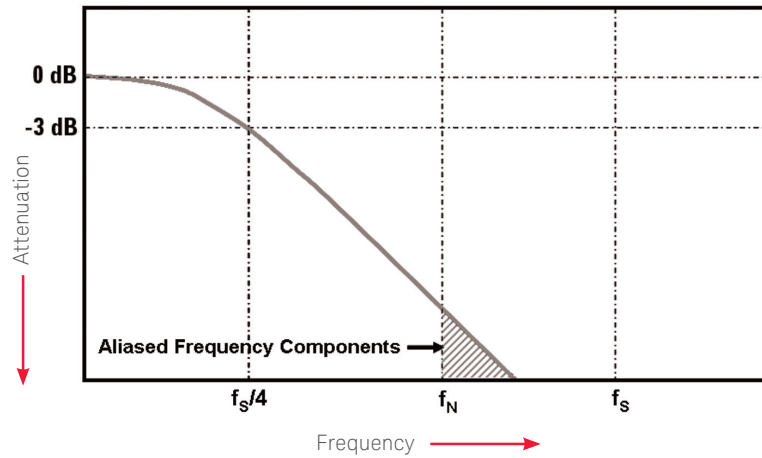

Figure 5: Limiting oscilloscope bandwidth (f_{BW}) to 1/4 the sample rate ($f_S/4$) reduces frequency components above the Nyquist frequency (f_N)

Oscilloscopes with bandwidth specifications in the 2-GHz and higher range typically have a sharper frequency roll-off response/characteristic. We call this type of frequency response a “maximally-flat” response. Since a scope with a maximally-flat response approaches the ideal characteristics of a brick-wall filter, where frequency components beyond the Nyquist frequency are attenuated to a higher degree, not as many samples are required to produce a good representation of the input signal using digital filtering. Vendors can theoretically specify the bandwidth of scopes with this type of response (assuming the front-end analog hardware is capable) at $f_S/2.5$. However, most scope vendors have not pushed this specification beyond $f_S/3$.

Nyquist's Sampling Theorem (continued)

Figure 6 shows a 500-MHz bandwidth scope capturing a 100-MHz clock signal with edge speeds in the range of 1 ns (10 to 90%). A bandwidth specification of 500 MHz would be the minimum recommended bandwidth to accurately capture this digital signal. This particular scope is able to sample at 4 GSa/s in a 2-channel mode of operation, or 2 GSa/s in a three- or four-channel mode of operation. Figure 6 shows the scope sampling at 2 GSa/s, which is twice the Nyquist frequency (f_N) and four times the bandwidth frequency (f_{BW}). This shows that a scope with a sample rate-to-bandwidth ratio of 4:1 produces a very stable and accurate representation of the input signal. And with $\text{Sin}(x)/x$ waveform reconstruction/interpolation digital filtering, the scope provides waveform and measurement resolution in the 10s of picoseconds range. The difference in waveform stability and accuracy is significant compared to the example we showed earlier (Figure 4) with a scope of the same bandwidth sampling at just twice the bandwidth (f_N).

So what happens if we double the sample rate to 4 GSa/s in this same 500-MHz bandwidth scope ($f_{BW} \times 8$)? You might intuitively believe that the scope would produce significantly better waveform and measurement results. But as you can see in Figure 7, there is some improvement, but it is minimal. If you look closely at these two waveform images (Figure 6 and Figure 7), you can see that when you sample at 4 GSa/s ($f_{BW} \times 8$), there is slightly less pre-shoot and over-shoot in the displayed waveform. But the rise time measurement shows the same results (1.02 ns). The key to this slight improvement in waveform fidelity is that additional error sources were not introduced when the sample-rate-to-bandwidth ratio of this scope increased from 4:1 (2 GSa/s) to 8:1 (4 GSa/s). And this leads us into our next topic:

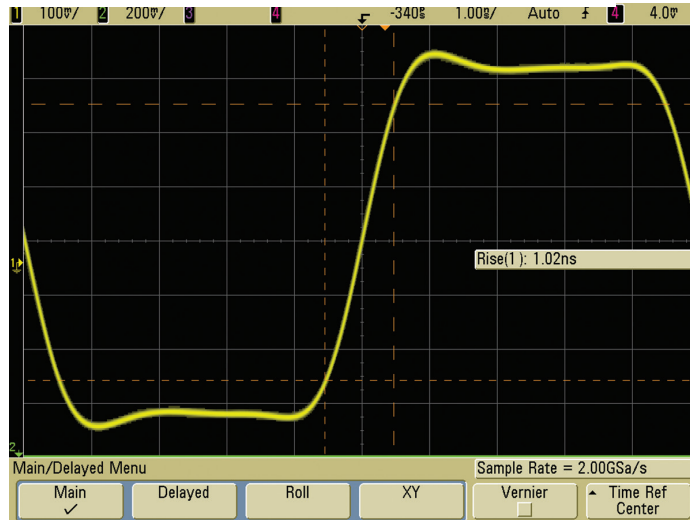

Figure 6: Keysight Technologies, Inc. 500-MHz bandwidth scope sampling at 2 GSa/s shows an accurate measurement of this 100-MHz clock with a 1-ns edge speed

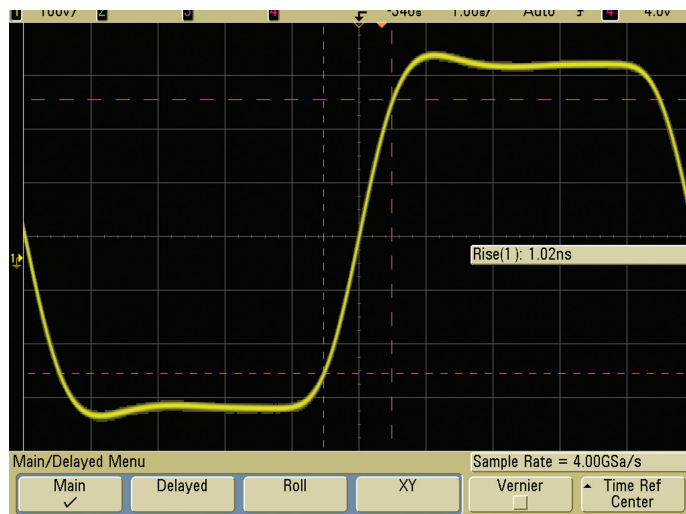

Figure 7: Keysight 500-MHz bandwidth scope sampling at 4 GSa/s produces minimal measurement improvement over sampling at 2 GSa/s

What happens if Nyquist's rule 2 is violated? Nyquist says that samples must be evenly spaced. Users often overlook this important rule when they evaluate digital storage oscilloscopes.

Interleaved Real-Time Sampling

When ADC technology has been stretched to its limit in terms of maximum sample rate, how do oscilloscope vendors create scopes with even higher sample rates? The drive for higher sample rates may be simply to satisfy scope users' perception that "more is better"—or higher sample rates may actually be required to produce higher-bandwidth real-time oscilloscope measurements. But producing higher sample rates in oscilloscopes is not as easy as simply selecting a higher sample rate off-the-shelf analog-to-digital converter.

A common technique adopted by all major scope vendors is to interleave multiple real-time ADCs. But don't confuse this sampling technique with interleaving samples from repetitive acquisitions, which we call "equivalent-time" sampling.

Figure 8 shows a block diagram of a real-time interleaved ADC system consisting of two ADCs with phase-delayed sampling. In this example, ADC 2 always samples $\frac{1}{2}$ clock period after ADC 1 samples. After each real-time acquisition cycle is complete, the scope's CPU or waveform processing ASIC retrieves the data stored in each ADC acquisition memory and then interleaves the samples to produce the real-time digitized waveform with twice the sample density (2X sample rate).

Scopes with real-time interleaved sampling must adhere to two requirements. For accurate distortion-free interleaving, each ADC's vertical gain, offset and frequency response must be closely matched. Secondly, the phase-delayed clocks must be aligned with high precision in order to satisfy Nyquist's rule 2 that dictates equally-spaced samples. In other words, the sample clock for ADC 2 must be delayed precisely 180 degrees after the clock that samples ADC 1. Both of these criteria are important for accurate interleaving. However, for a more intuitive understanding of the possible errors that can occur due to poor interleaving, the rest of this paper will focus on errors due to poor phase-delayed clocking.

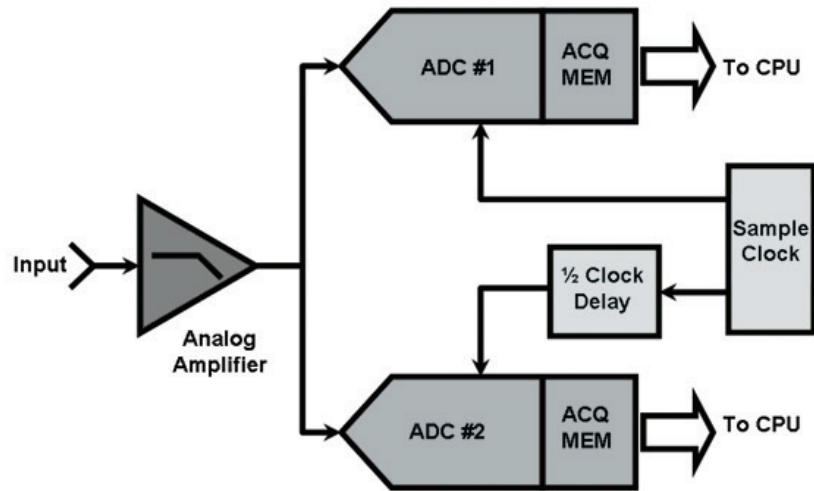

Figure 8: Real-time sampling system consisting of two interleaved ADCs

Interleaved Real-Time Sampling (continued)

The timing diagram shown in Figure 9 illustrates incorrect timing of interleaved samples if the phase-delayed clock system of two interleaved ADCs is not exactly $\frac{1}{2}$ sample period delayed relative to each other. This diagram shows where real-time digitized points (red dots) are actually converted relative to the input signal. But due to the poor alignment of phase-delayed clocking (purple waveforms), these digitized points are not evenly spaced, thus a violation of Nyquist's second rule.

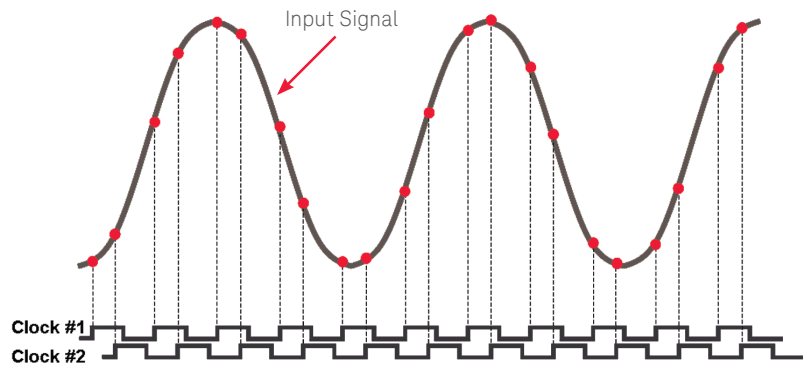

Figure 9: Timing diagram showing non-evenly spaced samples

When the scope's waveform processing engine retrieves the stored data from each ADC's acquisition memory, it assumes that samples from each memory device are equally spaced. In an attempt to reconstruct the shape on the original input signal, the scope's $\text{Sin}(x)/x$ reconstruction filter produces a severely distorted representation of the signal, as shown in Figure 10.

Since the phase relationship between the input signal and the scope's sample clock is random, real-time sampling distortion, which is sometimes referred to as "sampling noise," may be interpreted mistakenly as random noise when you are viewing repetitive acquisitions. But it is not random at all. It is deterministic and directly related to harmonics of the scope's sample clock.

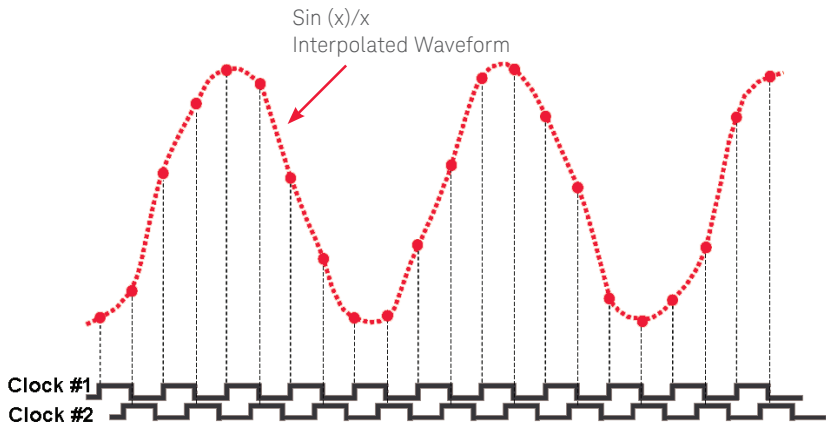

Figure 10: Timing diagram showing distorted reconstruction of waveform using a $\text{Sin}(x)/x$ filter due to poor phase-delayed clocking

Testing for Interleave Distortion

Unfortunately, oscilloscope vendors do not provide their customers with a specification in their DSO data sheets that directly quantifies the quality of their scope's digitizing process. However, there are a variety of tests that you can easily perform to not only measure the effect of sampling distortion, but also identify and quantify sampling distortion. Here is a list of tests you can perform on scopes to detect and compare interleave distortion:

Interleave distortion tests

1. Effective number of bits analysis using sine waves
2. Visual sine wave test
3. Spectrum analysis
4. Measurement stability

Effective number of bits analysis

The closest specification that some scope vendors provide to quantify sampling fidelity is effective number of bits (ENOB). But ENOB is a composite specification consisting of several error components including input amplifier harmonic distortion and random noise. Although an effective number of bits test can provide a good benchmark comparison of overall accuracy between scopes, effective bits is not a very well understood concept, and it requires exporting digitized data to a PC for number crunching. Basically, an effective number of bits test first extracts a theoretical best-fit sinusoidal signal from the digitized sine wave. This sine wave curve-fit algorithm will eliminate any errors induced by oscilloscope amplifier gain and offset inaccuracies. The test then computes the RMS error of the digitized sine wave relative to the ideal/extracted sine wave over one period. This RMS error is then compared to the theoretical RMS error that an ideal ADC of "N" bits would produce. For example, if a scope's acquisition system has 5.3 effective bits of accuracy, then it generates the same amount of RMS error that a perfect 5.3-bit ADC system would generate.

A more intuitive and easier test to conduct to see if a scope produces ADC interleave distortion is to simply input a sine wave from a high-quality signal generator with a frequency that approaches the bandwidth of the scope. Then just make a visual judgment about the purity of the shape of the digitized and filtered waveform.

ADC distortion due to misalignment can also be measured in the frequency domain using a scope's FFT math function. With a pure sine wave input, the ideal/non-distorted spectrum should consist of a single frequency component at the input frequency. Any other spurs in the frequency spectrum are components of distortion. You also can use this technique on digital clock signals, but the spectrum is a bit more complex, so you have to know what to look for.

Another easy test you can perform is to compare parametric measurement stability, such as the standard deviation of rise times, fall times, or V_{p-p} , between scopes of similar bandwidth. If interleave distortion exists, it will produce unstable measurements just like random noise.

Testing for Interleave Distortion (continued)

Visual sine wave comparison tests

Figure 11 shows the simplest and most intuitive comparative test—the visual sine wave test. The waveform shown in Figure 11a is a single-shot capture of a 200 MHz sine wave using a Keysight InfiniiVision 1-GHz bandwidth scope sampling at 4 GSa/s. This scope has a sample-rate-to-bandwidth ratio of 4:1 using non-interleaved ADC technology. The waveform shown in Figure 11b is a single-shot capture of the same 200 MHz sine wave using LeCroy's 1-GHz bandwidth scope sampling at 10 GSa/s. This scope has a maximum sample-rate-to-bandwidth ratio of 10:1 using interleaved technology.

Although we would intuitively believe that a higher-sample-rate scope of the same bandwidth should produce more accurate measurement results, we can see in this measurement comparison that the lower sample rate scope actually produces a much more accurate representation of the 200 MHz input sine wave. This is not because lower sample rates are better, but because poorly aligned interleaved real-time ADCs negate the benefit of higher sample rates.

Precision alignment of interleaved ADC technology becomes even more critical in higher bandwidth and higher sample rate scopes. Although a fixed amount of phase-delayed clock error may be insignificant at lower sample rates, this same fixed amount of timing error becomes significant at higher sample rates (lower sample periods). Let's now compare two higher-bandwidth oscilloscopes with and without real-time interleaved technology.

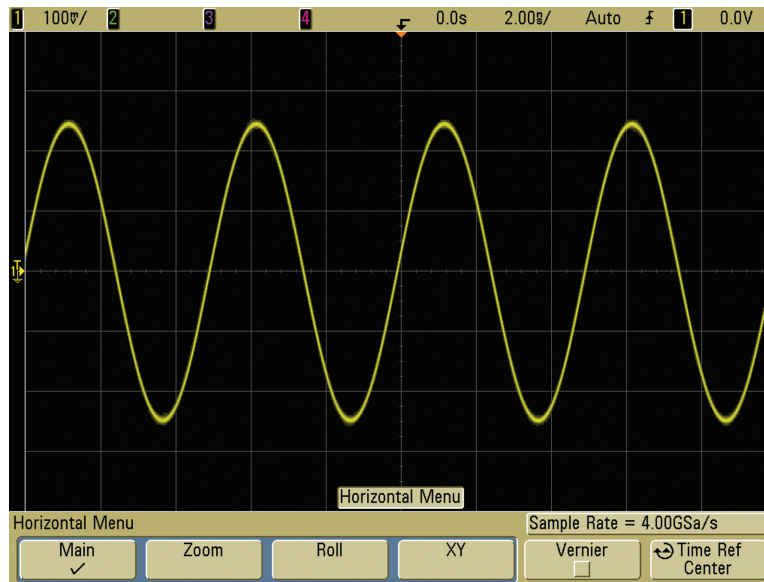

Figure 11a: 200-MHz sine wave captured on a Keysight 1-GHz bandwidth oscilloscope sampling at 4 GSa/s

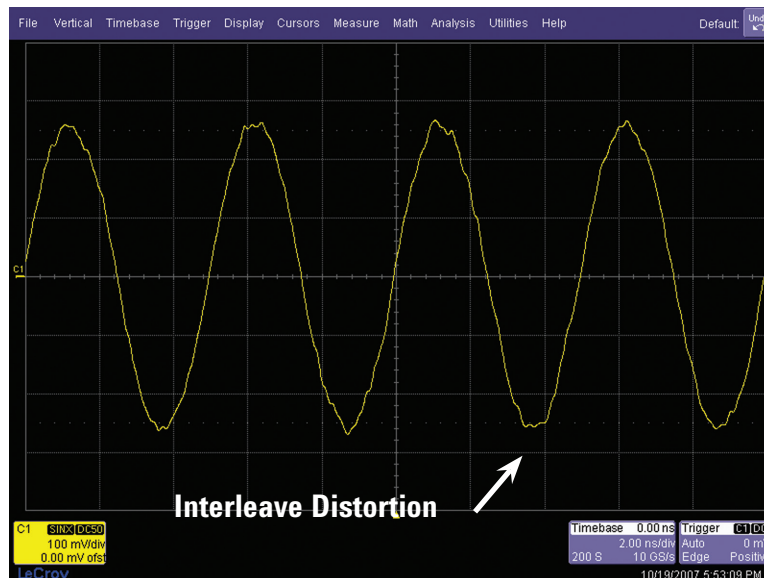

Figure 11b: 200-MHz sine wave captured on a LeCroy 1-GHz bandwidth oscilloscope sampling at 10 GSa/s

Testing for Interleave Distortion (continued)

Figure 12 shows two screen-shots of a visual sine wave test comparing a Keysight 3-GHz bandwidth scope sampling at 20 GSa/s (non-interleaved) and 40 GSa/s (interleaved) capturing a 2.5 GHz sine wave. This particular DSO uses single-chip 20 GSa/s ADCs behind each of four channels. But when using just two channels of the scope, the instrument automatically interleaves pairs of ADCs to provide up to 40 GSa/s real-time sampling.

Visually, we can't detect much difference between the qualities of these two waveforms. Both waveforms appear to be relatively "pure" sine waves with minimal distortion. But when we perform a statistical Vp-p measurement, we can see that the higher sample rate measurement produces slightly more stable measurement—as we would expect.

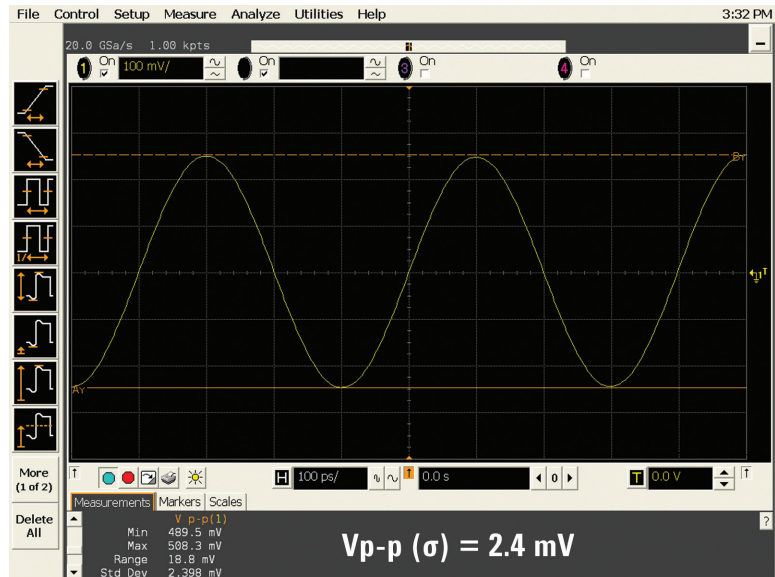

Figure 12a: 2.5-GHz sine wave captured on the Keysight Infiniium oscilloscope sampling at 20 GSa/s (non-interleaved)

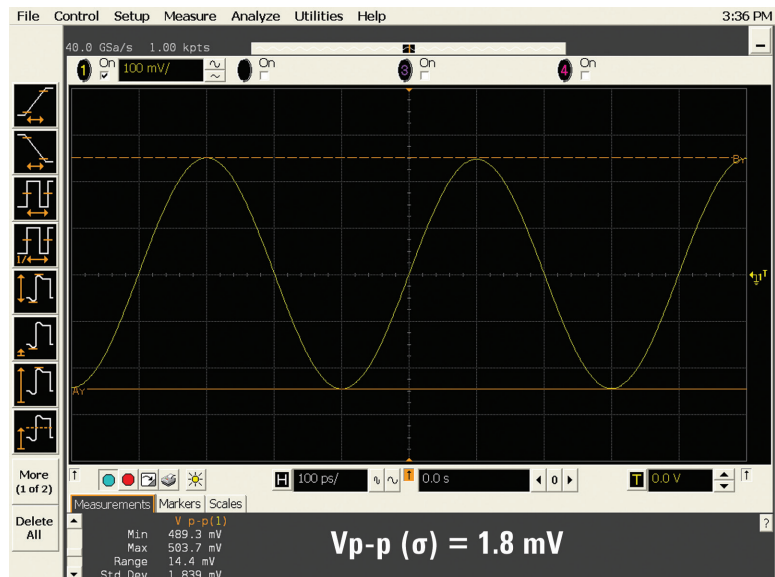

Figure 12b: 2.5-GHz sine wave captured on the Keysight Infiniium oscilloscope sampling at 40 GSa/s (interleaved)

Testing for Interleave Distortion (continued)

Figure 13 shows a visual sine wave test comparing the Tektronix 2.5-GHz bandwidth scope sampling at 10 GSa/s (non-interleaved) and 40 GSa/s (interleaved) capturing the same 2.5 GHz sine wave. This particular DSO uses single-chip 10 GSa/s ADCs behind each of four-channels. But when you use just one channel of the scope, the instrument automatically interleaves its four ADCs to provide up to 40 GSa/s real-time sampling on a single channel.

In this visual sine wave test we can see a big difference in waveform fidelity between each of these sample rate settings. When sampling at 10 GSa/s (Figure 13a) without interleaved ADCs, the scope produces a fairly good representation of the input sine wave, although the Vp-p measurement is approximately four times less stable than the measurement performed on the Keysight scope of similar bandwidth. When sampling at 40 GSa/s (Figure 13b) with interleaved ADC technology, we can clearly see waveform distortion produced by the Tek DSO, as well as a less stable Vp-p measurement. This is counter-intuitive. Most engineers would expect more accurate and stable measurement results when sampling at a higher rate using the same scope. The degradation in measurement results is primarily due to poor vertical and/or timing alignment of the real-time interleaved ADC system.

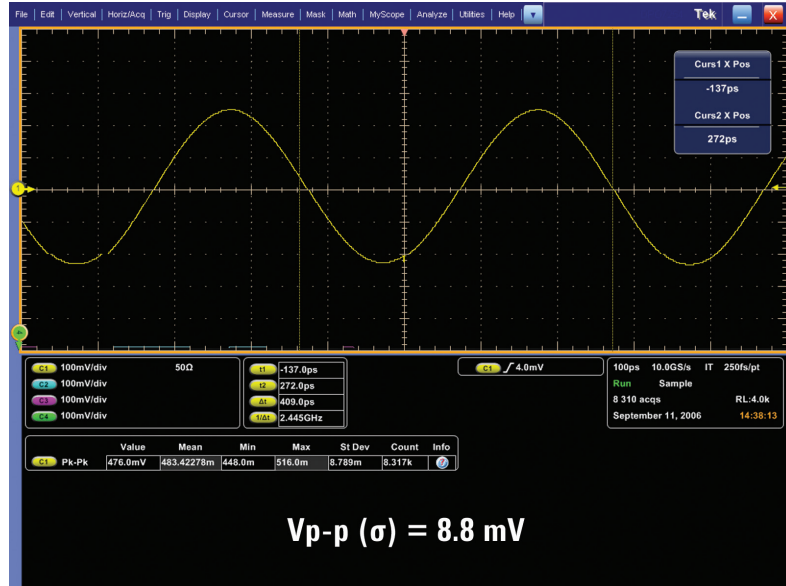

Figure 13a: 2.5-GHz sine wave captured on a Tektronix 2.5-GHz bandwidth oscilloscope sampling at 10 GSa/s (non-interleaved)

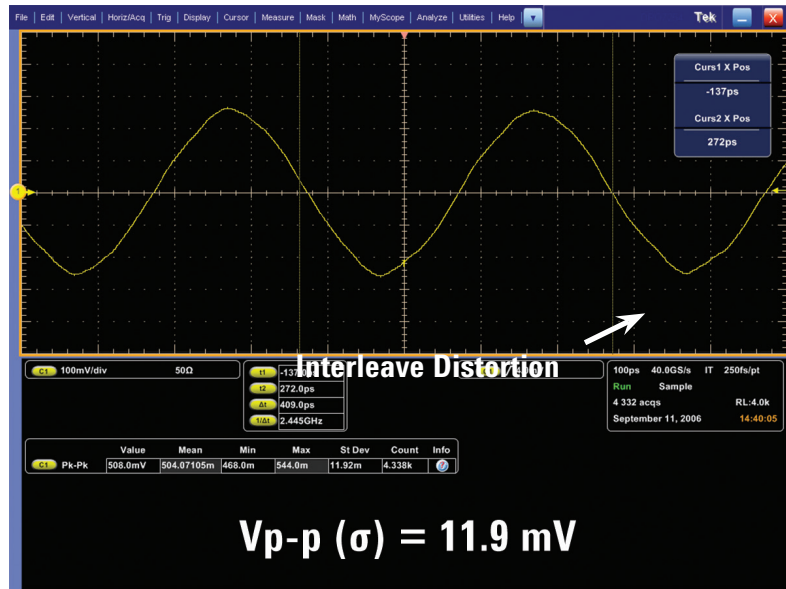

Figure 13b: 2.5-GHz sine wave captured on a Tektronix 2.5-GHz bandwidth oscilloscope sampling at 40 GSa/s (interleaved)

Testing for Interleave Distortion (continued)

Spectrum analysis comparison tests

The visual sine wave test doesn't really prove where the distortion is coming from. It merely shows the effect of various error/components of distortion. However, a spectrum/FFT analysis will positively identify components of distortion including harmonic distortion, random noise, and interleaved sampling distortion. Using a sine wave generated from a high-quality signal generator, there should be only one frequency component in the input signal. Any frequency components other than the fundamental frequency detected in an FFT analysis on the digitized waveform are oscilloscope-induced distortion components.

Figure 14a shows an FFT analysis of a single-shot capture of a 2.5 GHz sine wave using Keysight's Infiniium oscilloscope sampling at 40 GSa/s. The worst-case distortion spur measures approximately 90 dB below the fundamental. This component of distortion is actually second harmonic distortion, most likely produced by the signal generator. And its level is extremely insignificant and is even lower than the scope's in-band noise floor.

Figure 14b shows an FFT analysis of a single-shot capture of the same 2.5-GHz sine wave using a Tektronix oscilloscope—also sampling at 40 GSa/s. The worst-case distortion spur in this FFT analysis measures approximately 32 dB below the fundamental. This is a significant level of distortion and explains why the sine wave test (Figure 13b) produced a distorted waveform. The frequency of this distortion occurs at 7.5 GHz. This is exactly 10 GHz below the input signal frequency (2.5 GHz), but folded back into the positive domain. The next highest component of distortion occurs at 12.5 GHz.

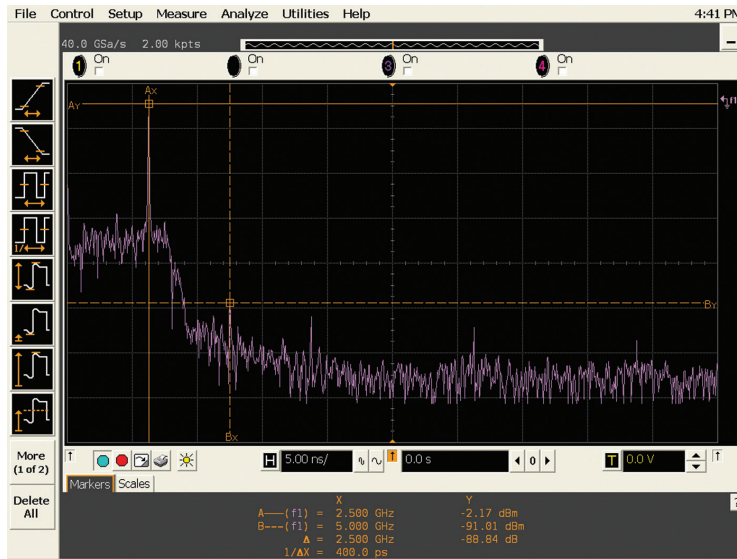

Figure 14a: FFT analysis of 2.5-GHz sine wave captured on a Keysight Infiniium oscilloscope sampling at 40 GSa/s

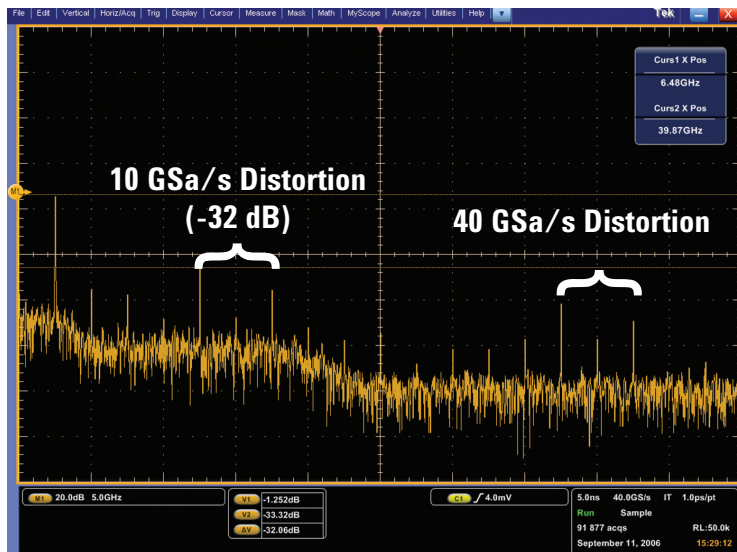

Figure 14b: FFT analysis of 2.5-GHz sine wave captured on a Tektronix oscilloscope sampling at 40 GSa/s

This is exactly 10 GHz above the input signal frequency (2.5 GHz). Both of these components of distortion are directly related to the 40-GSa/s sampling clock and its interleaved clock rates (10 GHz). These components of distortion are not caused by random or harmonic distortion. They are caused by real-time interleaved ADC distortion.

Testing for Interleave Distortion (continued)

Digital clock measurement stability comparison tests

As a digital designer, you may say that you really don't care about distortion on analog signals, such as on sine waves. But you must remember that all digital signals can be decomposed into an infinite number of sine waves. If the fifth harmonic of a digital clock is distorted, then the composite digital waveform will also be distorted.

Although it is more difficult to perform sampling distortion testing on digital clock signals, it can be done. But making a visual distortion test on digital signals is not recommended. There is no such thing as a "pure" digital clock generator. Digital signals, even those generated by the highest-performance pulse generators, can have varying degrees of overshoot and perturbations, and can have various edge speeds. In addition, pulse shapes of digitized signals can be distorted by the scope's front-end hardware due to the scope's pulse response characteristics and possibly a non-flat frequency response.

But there are a few tests you can perform using high-speed clock signals to compare the quality of a scope's ADC system. One test is to compare parametric measurement stability, such as the standard deviation of rise times and fall times. Interleave sampling distortion will contribute to unstable edge measurements and inject a deterministic component of jitter into the high-speed edges of digital signals.

Figure 15 shows two scopes with similar bandwidth capturing and measuring the rise time of a 400 MHz digital clock signal with edge speeds in the range of 250 ps. Figure 15a shows a Keysight 3 GHz bandwidth scope interleaving two 20-GSa/s ADC in order to sample this signal at 40 GSa/s. The resultant repetitive rise time measurement has a

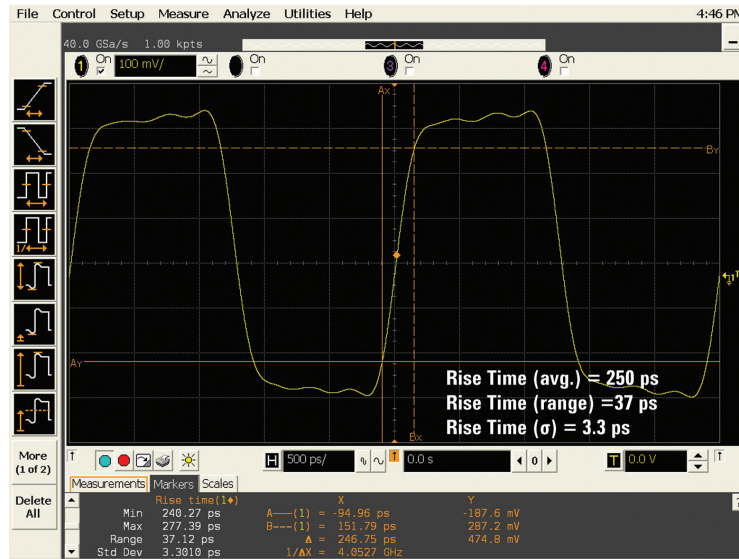

Figure 15a: 400-MHz clock captured on a Keysight Infiniium 3-GHz oscilloscope sampling at 40 GSa/s

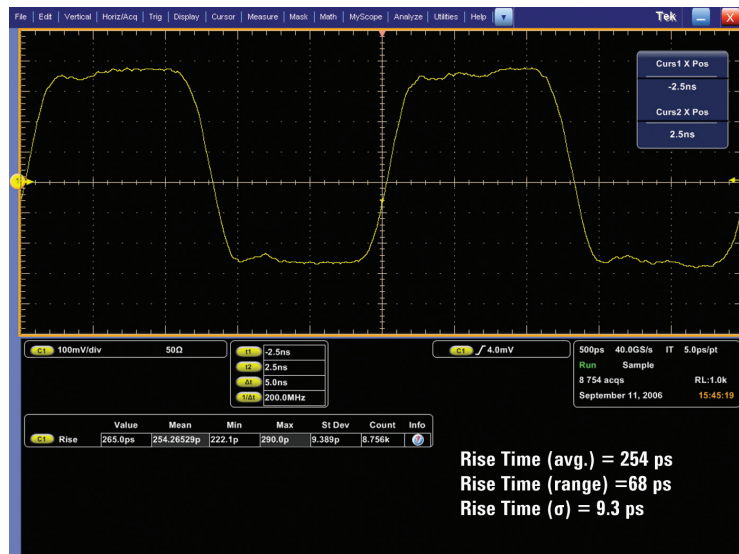

Figure 15b: 400-MHz clock captured on a Tektronix 2.5-GHz oscilloscope sampling at 40 GSa/s

standard deviation of 3.3 ps. Figure 15b shows a Tektronix 2.5 GHz bandwidth scope interleaving four 10 GSa/s ADCs in order to also sample at 40 GSa/s. In addition to a more unstable display, the rise time measurement on this digital clock has a standard deviation of 9.3 ps. The more tightly aligned ADC

interleaving in the Keysight scope, along with a lower noise floor, makes it possible for the Keysight scope to more accurately capture the higher-frequency harmonics of this clock signal, thereby providing more stable measurements.

Testing for Interleave Distortion (continued)

When you view the frequency components of a digital clock signal using FFT analysis, the spectrum is much more complex than when you test a simple sine wave. A pure digital clock generated from a high-quality pulse generator should consist of the fundamental frequency component and its odd harmonics. If the duty cycle of the clock is not exactly 50%, then the spectrum will also contain lower-amplitude even harmonics. But if you know what to look for and what to ignore, you can measure interleave sampling distortion on digital signals in the frequency domain using the scope's FFT math function.

Figure 16a shows the spectrum of a 400-MHz clock captured on a Keysight 3-GHz bandwidth scope sampling at 40 GSa/s. The only observable frequency spurs are the fundamental, third harmonic, fifth harmonic, and seventh harmonic—along with some minor even harmonics. All other spurs in the spectrum are well below the scope's in-band noise floor.

Figure 16b shows the spectrum of a 400 MHz clock captured on a Tektronix 2.5 GHz bandwidth scope—also sampling at 40 GSa/s. In this FFT analysis, we not only see the fundamental frequency component and its associated harmonics, but we also see several spurs at higher frequencies clustered around 10 GHz and 40 GHz. These imaging spurs are directly related to this scope's poorly aligned interleaved ADC system.

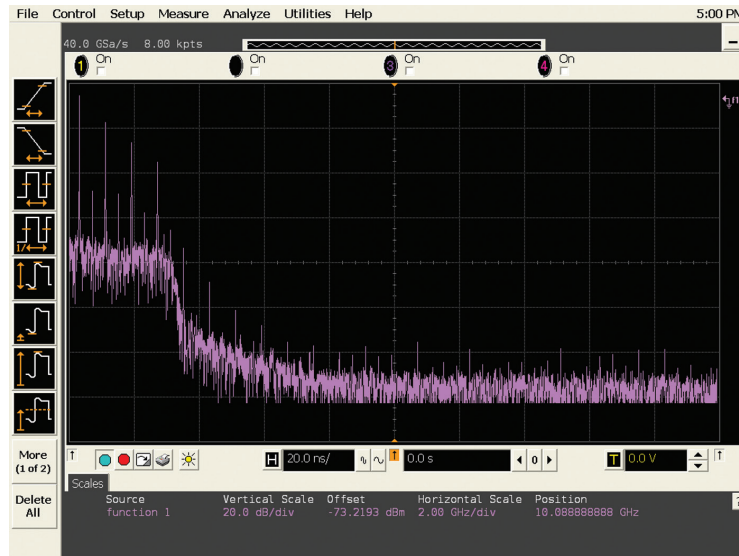

Figure 16a: FFT analysis on a 400-MHz clock using a Keysight Infiniium 3-GHz bandwidth oscilloscope

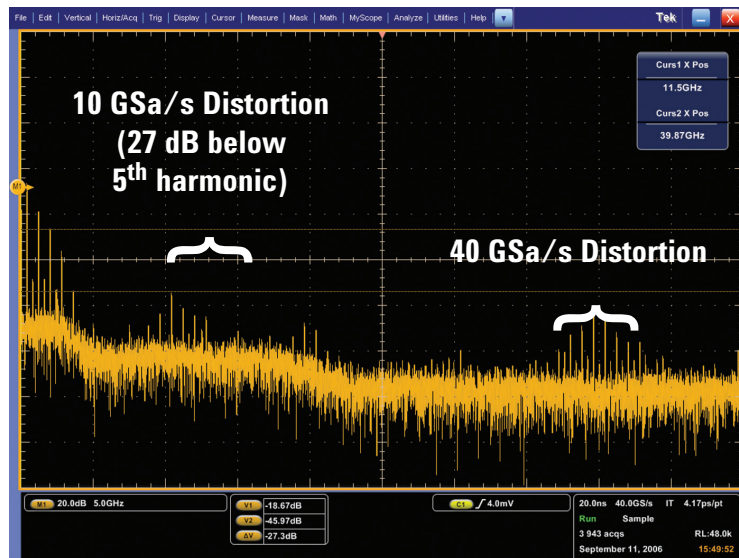

Figure 16b: FFT analysis on a 400-MHz clock using a Tektronix 2.5-GHz bandwidth oscilloscope

Summary

As you've read in this application note, there's more to oscilloscope signal fidelity than just sample rate. In some cases a lower-sample-rate scope may produce more accurate measurement results.

To satisfy Nyquist criteria, you need a scope that samples at least three to five times higher than the scope's bandwidth specification, depending on the scope's frequency roll-off characteristics. Achieving higher sample rates often requires that scope vendors interleave multiple real-time ADCs. But if real-time interleaving is employed, it is critical that the interleaved ADCs be vertically matched and the timing of phase-delayed clocking must be precise. It should be noted that the problem is not the number of interleaved ADCs; the issue is the level of precision of interleaving. Otherwise, Nyquist's second rule (equally-spaced samples) can be violated, thereby producing distortion and often negating the expected benefit of higher sample rates.

When you compare waveform fidelity of similar bandwidth scopes, Keysight's real-time scopes produce the truest representation of input signals using the industry's highest-precision ADC technology.

Related Keysight Literature

Publication	Description	Publication number
<i>InfiniiVision 2000 X-Series Oscilloscopes</i>	Data Sheet	5990-6618EN
<i>InfiniiVision 3000 X-Series Oscilloscopes</i>	Data Sheet	5990-6619EN
<i>InfiniiVision 4000 X-Series Oscilloscopes</i>	Data Sheet	5991-1103EN
<i>InfiniiVision 6000 X-Series Oscilloscopes</i>	Data Sheet	5990-3746EN
<i>Infiniium S-Series Oscilloscopes</i>	Data Sheet	5991-4028EN
<i>Infiniium 90000 X-Series Oscilloscopes</i>	Data Sheet	5990-5271EN
<i>Keysight InfiniiVision Series Oscilloscope Probes and Accessories</i>	Data Sheet	5968-8153EN
<i>Evaluating Oscilloscope Bandwidths for Your Applications</i>	Application Note	5989-5733EN
<i>Advantages and Disadvantages of Using DSP Filtering on Oscilloscope Waveforms</i>	Application Note	5989-1145EN
<i>Understanding Oscilloscope Frequency Response and Its Effect on Rise Time Accuracy</i>	Application Note	5988-8008EN
<i>Evaluating Oscilloscope Vertical Noise Characteristics</i>	Application Note	5989-3020EN
<i>Oscilloscope Waveform Update Rate Determines Probability of Capturing Elusive Events</i>	Application Note	5989-7885EN
<i>Evaluating Oscilloscopes to Debug Mixed-Signal Designs</i>	Application Note	5989-3702EN

Product Web site

For the most up-to-date and complete application and product information, please visit our product Web site at: www.keysight.com/find/scopes

Glossary

ADC	Analog-to-digital converter
Aliasing	Waveform errors produced by a digital filter when reconstructing a sampled signal that contains frequency components above the Nyquist frequency (f_S)
Brick-wall frequency response	A theoretical hardware or software filter that perfectly passes all frequency components below a specific frequency and perfectly eliminates all frequency components above the same frequency point
DSO	Digital storage oscilloscope
Equivalent-time sampling	A sampling technique that interleaves samples taken from repetitive acquisitions
FFT	Fast Fourier transform
Gaussian frequency response	A low-pass frequency response that has a slow roll-off characteristic that begins at approximately 1/3 the -3 dB frequency (bandwidth). Oscilloscopes with bandwidth specifications of 1 GHz and below typically exhibit an approximate Gaussian response.
In-band	Frequency components below the -3 dB (bandwidth) frequency
Interleaved real-time sampling	A sampling technique that interleaves samples from multiple real-time ADCs using phase-delayed clocking
Maximally-flat response	A low-pass frequency response that is relatively flat below the -3 dB frequency and then rolls-off sharply near the -3 dB frequency (bandwidth). Oscilloscopes with bandwidth specifications greater than 1 GHz typically exhibit a maximally-flat response
Nyquist sampling theorem	States that for a limited bandwidth (band-limited) signal with maximum frequency (f_{max}), the equally-spaced sampling frequency f_S must be greater than twice the maximum frequency f_{max} , in order to have the signal be uniquely reconstructed without aliasing
Oscilloscope bandwidth	The lowest frequency at which input signal sine waves are attenuated by 3 dB (-30% amplitude error)
Out-of-band	Frequency components above the -3 dB (bandwidth) frequency
Real-time sampling	A sampling technique that acquires samples in a single-shot acquisition at a high rate.
Sampling noise	A deterministic component of distortion related to a scope's sample clock

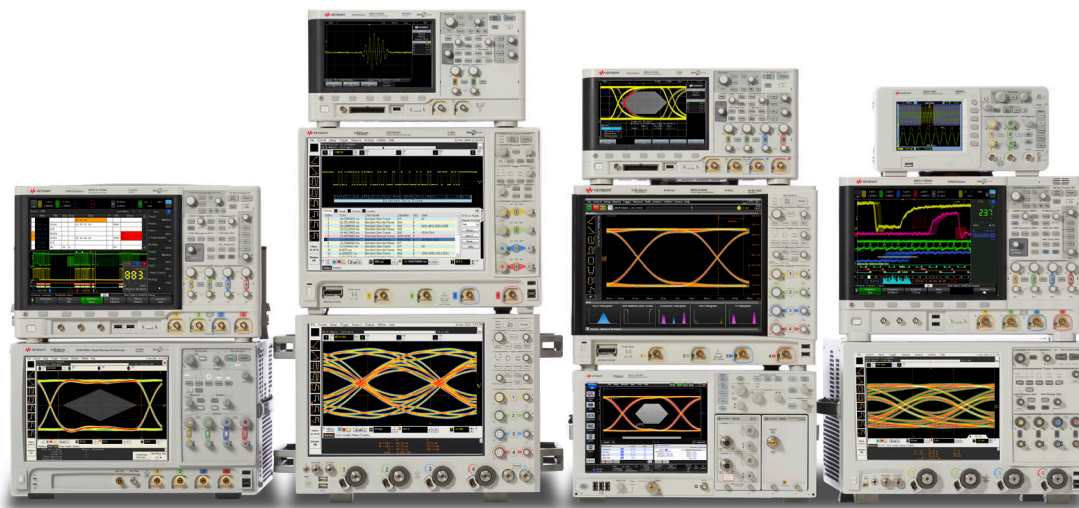

Keysight Oscilloscopes

Multiple form factors from 20 MHz to > 90 GHz | Industry leading specs | Powerful applications



myKeysight

www.keysight.com/find/mykeysight

A personalized view into the information most relevant to you.



www.axiestandard.org

AdvancedTCA® Extensions for Instrumentation and Test (AXIe) is an open standard that extends the AdvancedTCA for general purpose and semiconductor test. Keysight is a founding member of the AXIe consortium. ATCA®, AdvancedTCA®, and the ATCA logo are registered US trademarks of the PCI Industrial Computer Manufacturers Group.



www.lxistandard.org

LAN eXtensions for Instruments puts the power of Ethernet and the Web inside your test systems. Keysight is a founding member of the LXI consortium.



www.pxisa.org

PCI eXtensions for Instrumentation (PXI) modular instrumentation delivers a rugged, PC-based high-performance measurement and automation system.



Three-Year Warranty

www.keysight.com/find/ThreeYearWarranty

Keysight's commitment to superior product quality and lower total cost of ownership. The only test and measurement company with three-year warranty standard on all instruments, worldwide.



Keysight Assurance Plans

www.keysight.com/find/AssurancePlans

Up to five years of protection and no budgetary surprises to ensure your instruments are operating to specification so you can rely on accurate measurements.



www.keysight.com/quality

Keysight Technologies, Inc.
DEKRA Certified ISO 9001:2008
Quality Management System

Keysight Channel Partners

www.keysight.com/find/channelpartners

Get the best of both worlds: Keysight's measurement expertise and product breadth, combined with channel partner convenience.

www.keysight.com/find/scopes

For more information on Keysight Technologies' products, applications or services, please contact your local Keysight office. The complete list is available at: www.keysight.com/find/contactus

Americas

Canada	(877) 894 4414
Brazil	55 11 3351 7010
Mexico	001 800 254 2440
United States	(800) 829 4444

Asia Pacific

Australia	1 800 629 485
China	800 810 0189
Hong Kong	800 938 693
India	1 800 112 929
Japan	0120 (421) 345
Korea	080 769 0800
Malaysia	1 800 888 848
Singapore	1 800 375 8100
Taiwan	0800 047 866
Other AP Countries	(65) 6375 8100

Europe & Middle East

Austria	0800 001122
Belgium	0800 58580
Finland	0800 523252
France	0805 980333
Germany	0800 6270999
Ireland	1800 832700
Israel	1 809 343051
Italy	800 599100
Luxembourg	+32 800 58580
Netherlands	0800 0233200
Russia	8800 5009286
Spain	0800 000154
Sweden	0200 882255
Switzerland	0800 805353
	Opt. 1 (DE)
	Opt. 2 (FR)
	Opt. 3 (IT)
United Kingdom	0800 0260637

For other unlisted countries:
www.keysight.com/find/contactus
(BP-07-10-14)

